

# Flat Panel Drapery Installation Instructions

For Drapery Rod with Rings

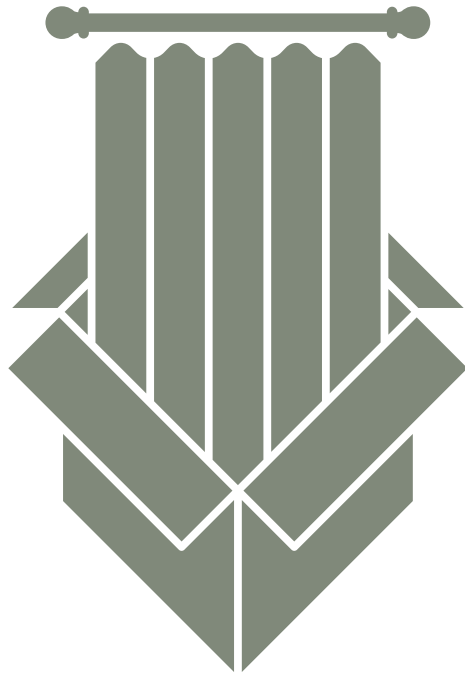

Let's get excited for your new drapes. Please take a few minutes to review these simple steps so your drapes will be hanging beautifully in no time.

## Before You Begin

Please note that:

- Drapery pins are pre-installed on the backside of your drapes, approximately 7 inches apart. Please check that no pins have detached during shipping, and you have the right number of rings on your rod.
- Drapery pins can be adjusted to suit your needs. You can space them differently to adjust the folds or raise and lower them to adjust the height.
- The only separate hardware (included in the envelope with the printed instructions) are the wall hooks. You will need one wall hook for every drapery panel (two for a pair). If your order includes tiebacks, an additional wall hook will be included with each tieback.
- If you ordered drapery wands, they might be shipped with your hardware.
- You will need a hammer, pencil, and measuring tape to position and install the wall hooks.

Please contact Customer Care if you need additional pins or hooks at 1-800-256-5005.

## Flat Panel Drapery Installation Steps

### Step 1 – Unpacking Drapes

Unpack all drapes and identify left and right panels by checking the tags sewn into the top corners. Sort your drapes first by window / room if you have more than one window in your order.

### Step 2 – Mounting Drapes

Typically, the most outer rings on the rod are placed between the finial and the bracket.

Start installing your drapes from this outer ring first, attach the second-from-last drapery pin to this outer ring, and continue toward the center. Leave the first drapery pin on the outer edge for the wall hook.

Follow Step 3 on how to attach the leading edge (center) drapery pin

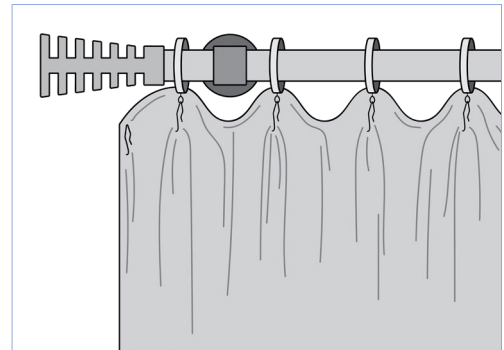

### Step 3 – Leading Edge Pin

Attach the leading edge drapery pin in the opposite direction as shown in the Step 3 pictures.

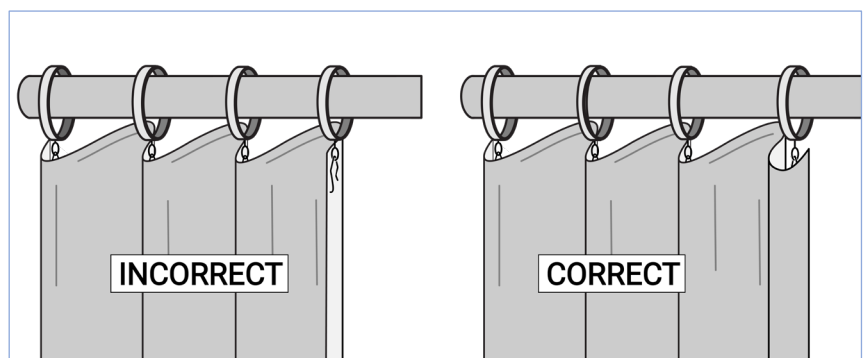

## Flat Panel Drapery Installation Steps

(Cont'd)

### Step 4 – Wall Hook Installation

Use included wall hooks and screw them into the wall at the height of the drapery pins. Choose a wall hook location that creates a finished look for the last fold and blocks light from seeping between the drape and the wall.

Please note that it is recommended to pre-drill the pilot hole or install the #4 anchor first. Use a 1/16" drill bit for a pilot hole or 3/16" drill bit for the anchor

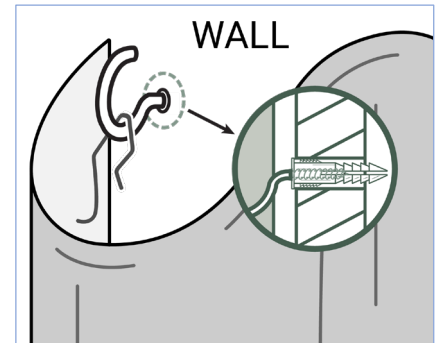

### Step 5 – Tiebacks Installation (optional)

We recommend installing your tieback approximately halfway down the height of your drapes. Wrap tieback around the drape and adjust the height up or down to find the perfect location.

When you find the perfect height for the tieback, mark the location and install the wall hook by the mark. Pre-drill the pilot hole or install the #4 anchor first. Use a 1/16" drill bit for a pilot hole or 3/16" drill bit for the anchor.

Attach the second wall hook on the other side at the same height if you have a pair.

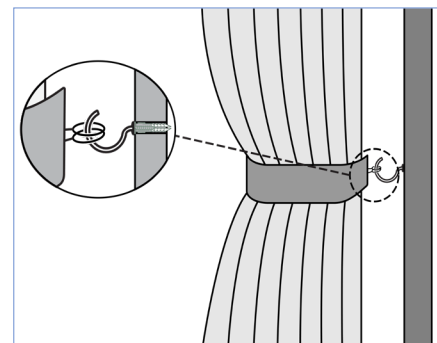

### Step 6 – Attaching Drapery Wand (optional)

Attach wand to the first leading (center) ring as shown in the picture.

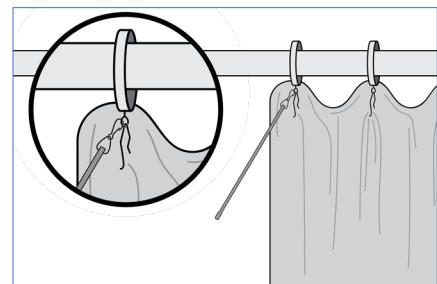

### Step 7 – Stabilizing Drapery Folds (optional)

Use the enclosed ball chain to stabilize drape folds while closing and opening the drape.

Count the number of drapery pins on each of drapery panels.

Mark the places on the chain where it will be attached to the drapery pins. Spread the marks evenly, placing the first and the last marks at the ends of the chain.

Hook in the chain through the drapery pin at the marked places. Check you can fully close/open the drapes. If needed, adjust the chain position.

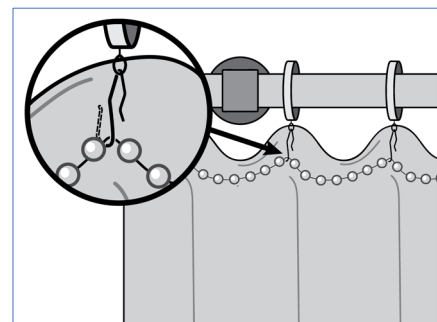

## How to Dress Flat Panel Drapes

Dressing drapes will create memory in the fabric so every time you open or close your drapes the fabric will be folded similarly. Dressing the folds usually takes 2 - 3 days for lighter fabric. For heavier fabric or drapes with interlining it might take up to two weeks. During this time, your drapes should stay in the open position, and we recommend not closing them to allow folds to create memory.



Dressing Flat Panel Video

### Step 1 – Start Dressing

Start with the outermost ring because it is locked between the finial and the bracket.

### Step 2 – Creating Folds

Create a fold around the drapery pin by holding fabric around the drapery pin on top of the panel. This will create the front end of the fold.

While holding the fabric around the drapery pin, run your fingers all the way down the sides to finish the fold. This way the back end of the fold will go toward the wall. Continue creating the fold for every ring of your drapes.

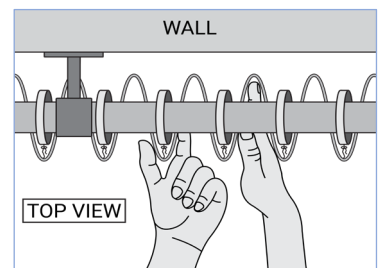

### Step 3 – Tying Folded Drapes (Optional)

Optionally, use a ribbon or light rope to tie the folds on the top, close to the drapery pins.

While the top of the drape is tied together, make the folds all the way down to the floor and tie the drape at the middle and bottom. The folds will form all the way from top to bottom and the panel will keep its shape whether open or closed.

Keep your drape tied for a few days.

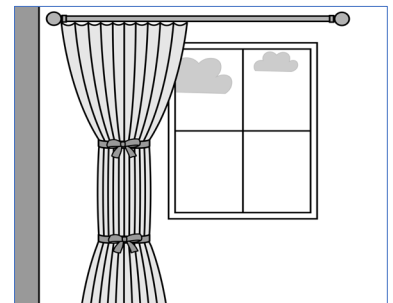

## Drapery Care

Once the draperies are installed and dressed, most wrinkles and folds will hang out on their own within 1 - 2 weeks.

A garment steamer may also be used to help smooth out the wrinkles. Please take care not to overheat the fabric while removing wrinkles. You also can use a wrinkle release spray like Downy® Wrinkle Releaser.

Certain fabrics like silks or linens have natural characteristics that steaming will not remove.

Please contact Customer Care at 1-800-256-5005 if you have additional questions how to care for your drapes.



Thank you for choosing Regal Drapes. We are proud to make your drapes with careful attention to every detail. We hope you enjoy your drapes for many years to come.

The Regal Drapes Team