

# URBAN DRAPERY HARDWARE INSTALLATION INSTRUCTIONS

## CEILING MOUNT

### FIRST TIME INSTALLING DRAPES?

DON'T WORRY, WE'LL WALK YOU THROUGH THE WHOLE PROCESS. JUST FOLLOW THESE SIMPLE STEPS AND YOU'RE NEARLY THERE.



NEED MORE INFORMATION?



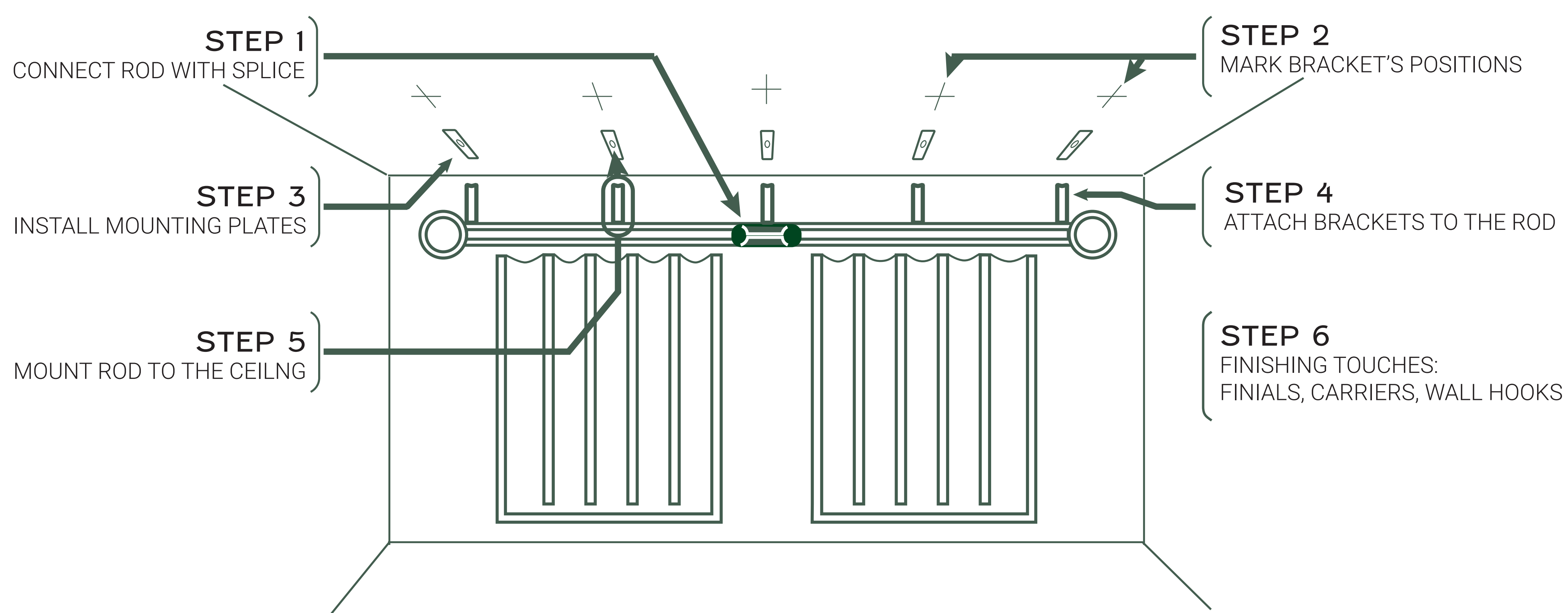



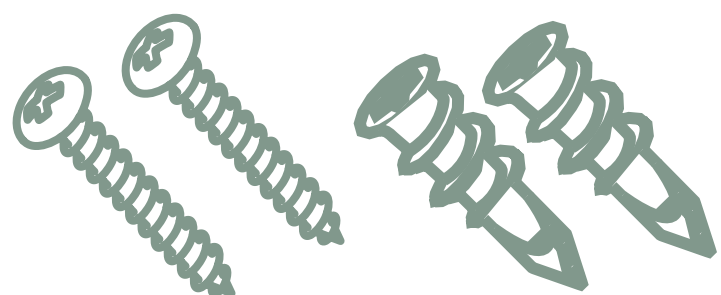
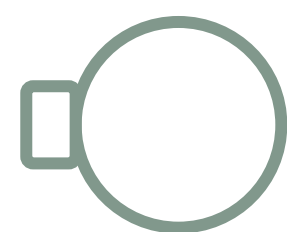
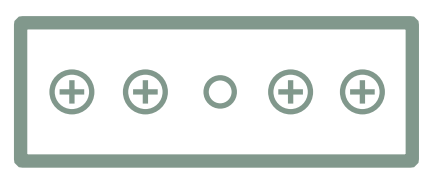

### INSTALLATION AT A GLANCE

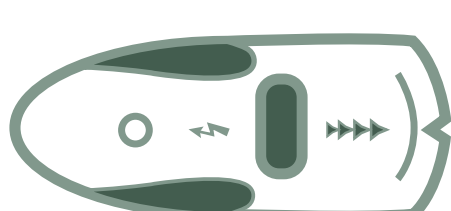

### PARTS YOU GET

<b>DRAPERY ROD</b> 	<b>CEILING OR FLUSH BRACKETS</b> 	<b>ALLEN KEYS</b> 
<b>SCREWS &amp; ANCHORS</b> 	<b>FINIALS</b> 	<b>SPLICE</b> 
<b>PREINSTALLED ON THE ROD</b>		

### TOOLS YOU WILL NEED

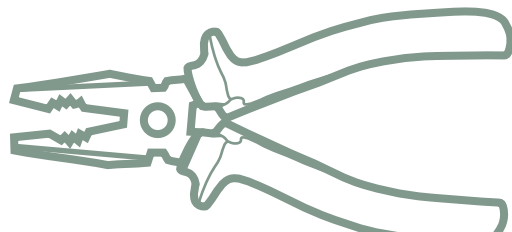
<b>DRILL, PHILLIPS &amp; DRILL BITS</b> 	<b>STEP STOOL</b> 	<b>TAPE MEASURE</b> 	<b>STUD FINDER (OPTIONAL)</b> 
<b>LEVEL (OPTIONAL)</b> 	<b>PEN OR PENCIL</b> 	<b>PROTECTIVE GEAR</b> 	<b>PLIERS</b> 

## STEP 1 CONNECTING ROD WITH SPLICE (OPTIONAL)

**1** Loosen the screws on preinstalled splice.

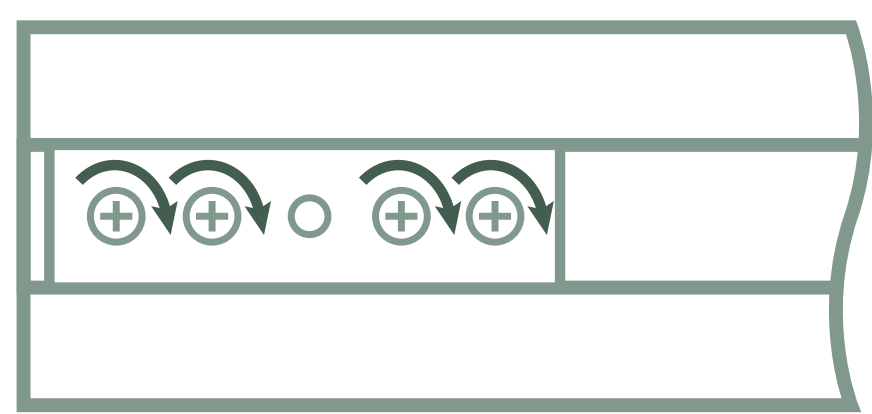

**2** Move the splice halfway out (1) and tighten the screws (2).

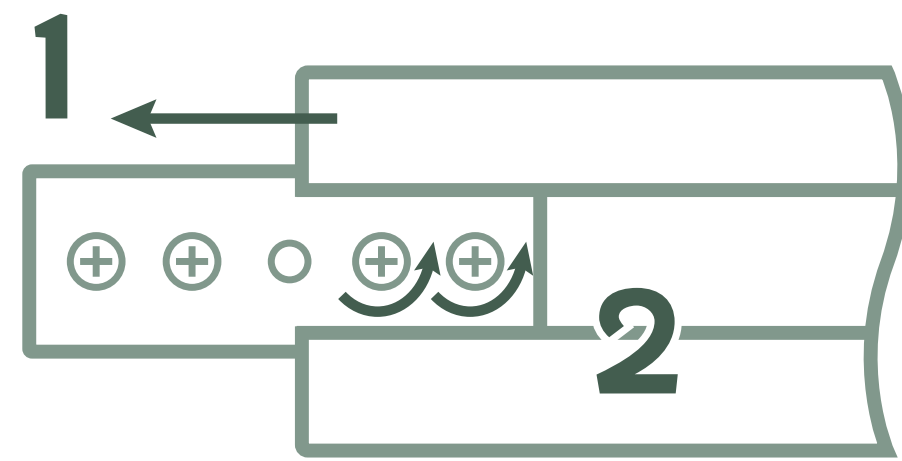

**3** Connect the second rod half (1) so ends are connected (2) and tighten the screws (3).

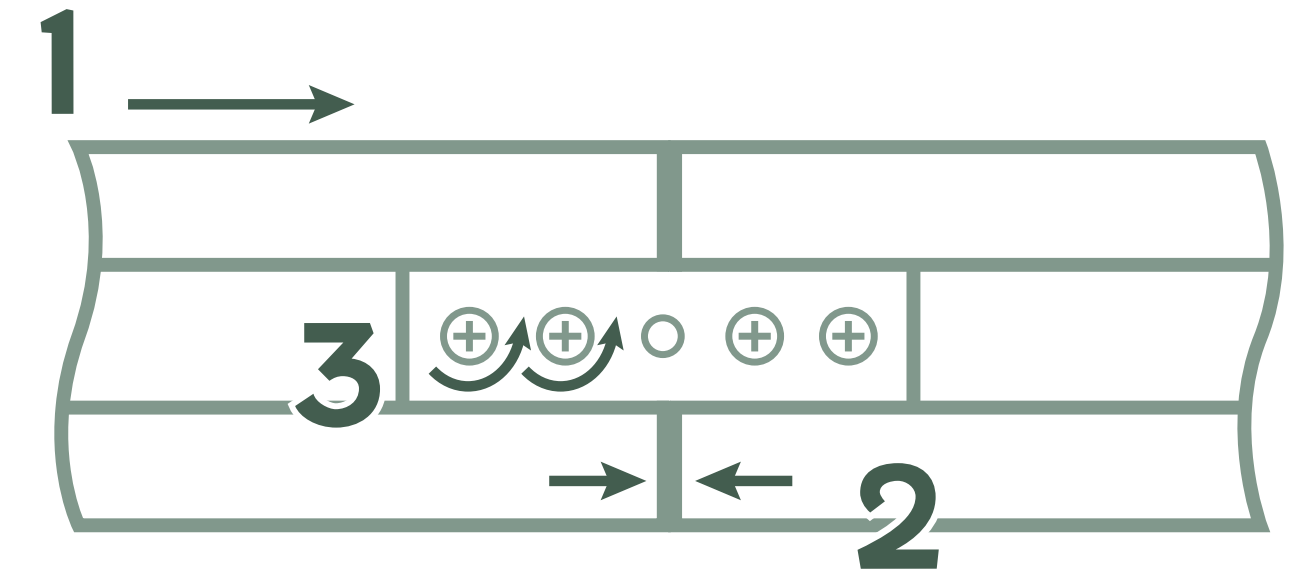

## STEP 2 MARKING BRACKET PLACEMENT - CEILING MOUNT

**1** Measure the width of your drapery rod. Do not include the finials in the final measurement.

**2** Put the end brackets marks 3-4 inches from the wall, symmetrical to the window, and 3-4 inches in from the rod ends.

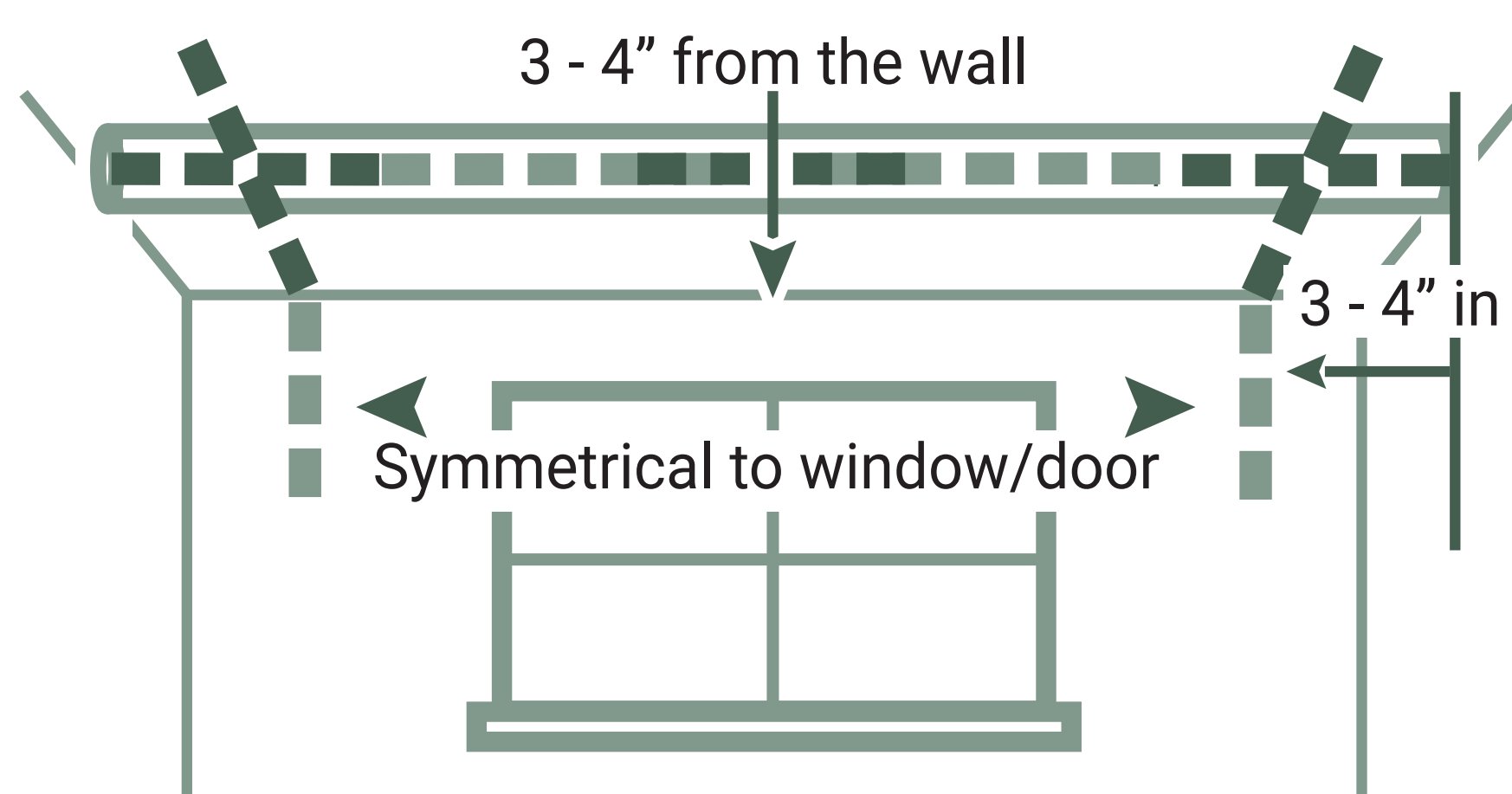

**3** Spread the other marks evenly between the two end marks. If needed, move them to catch a ceiling joist. Use a stud finder if needed.

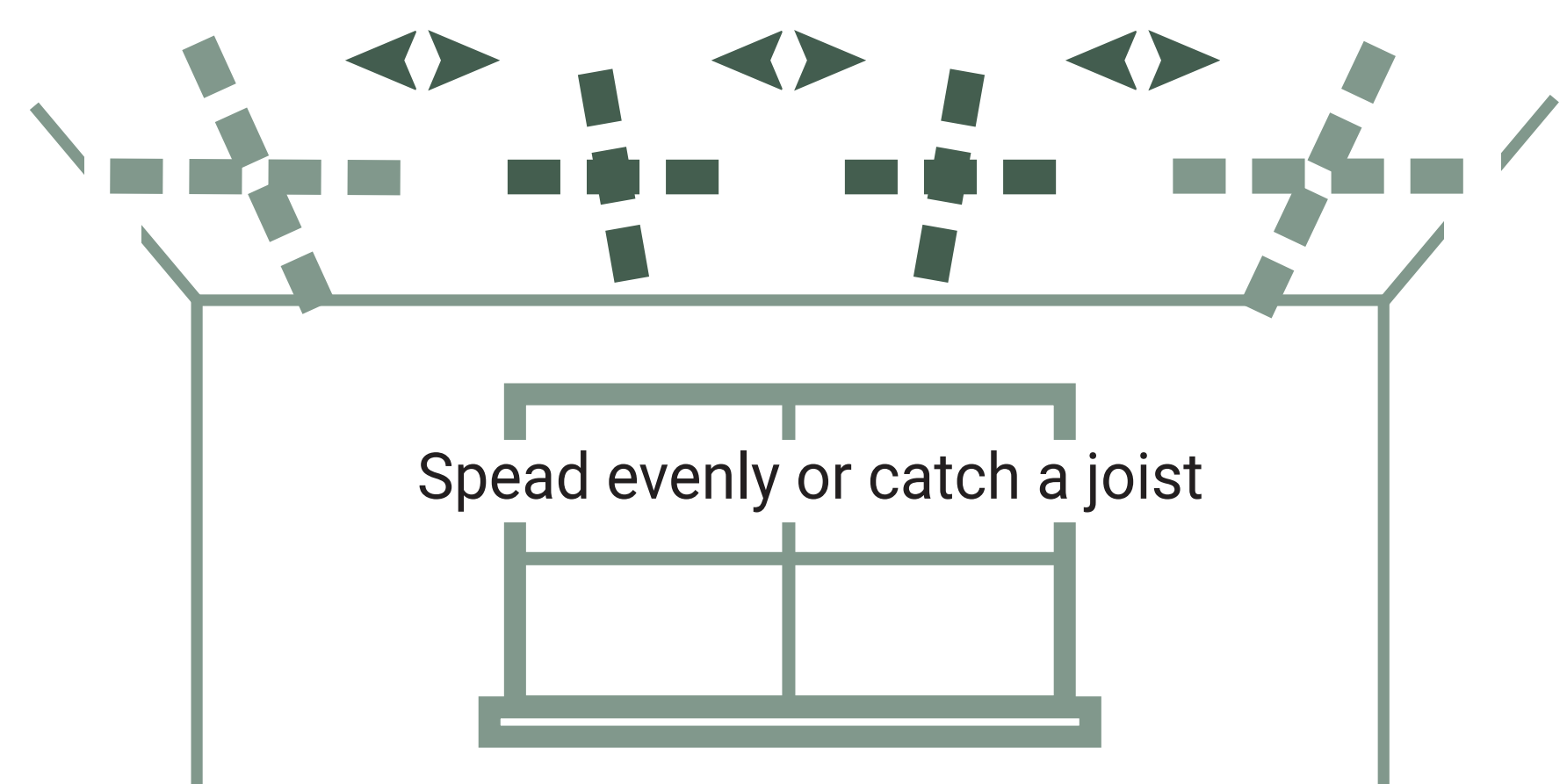

**4** Make sure that all marks are placed in a straight line.

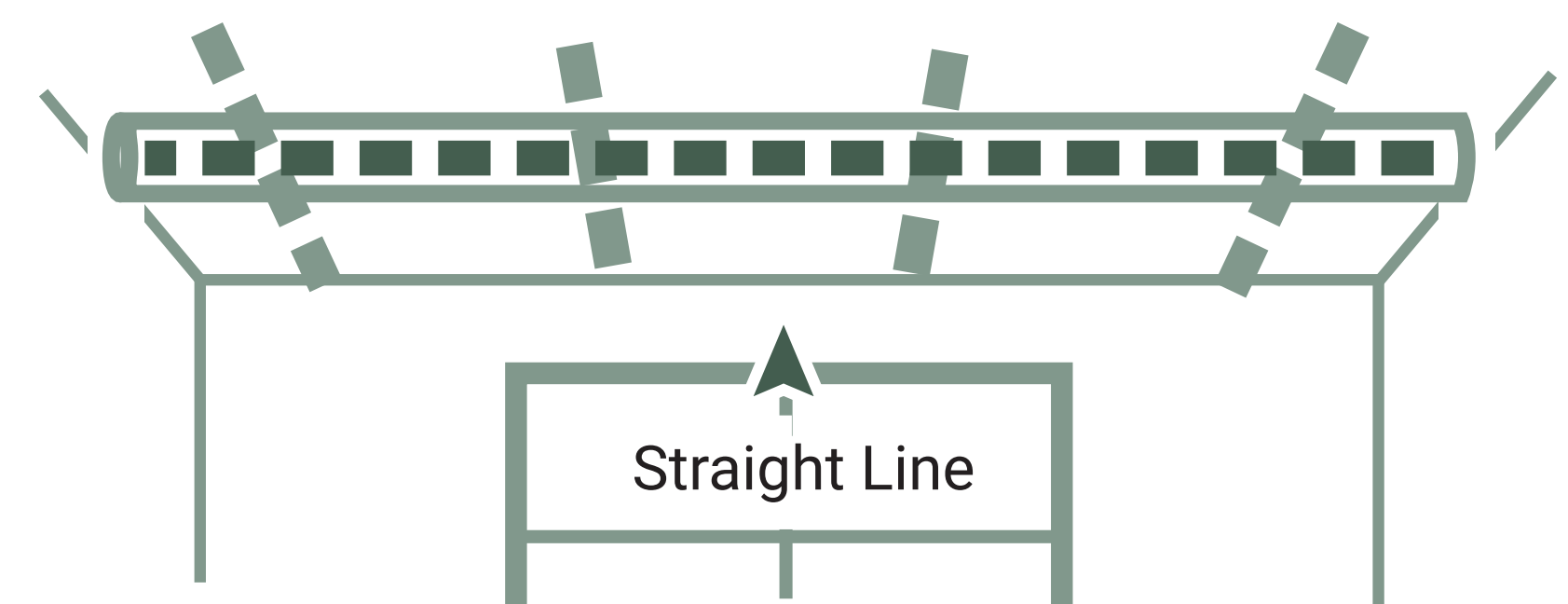

## STEP 3 INSTALL MOUNTING PLATES

 For flash ceiling brackets complete Step 4 only - install anchors or pre-drill pilot hole.

**1** Detach the mounting plate from the bracket.



**2** Place the mounting plate center of on the mark.



**3** Use holes to mark the position for screws or anchors.

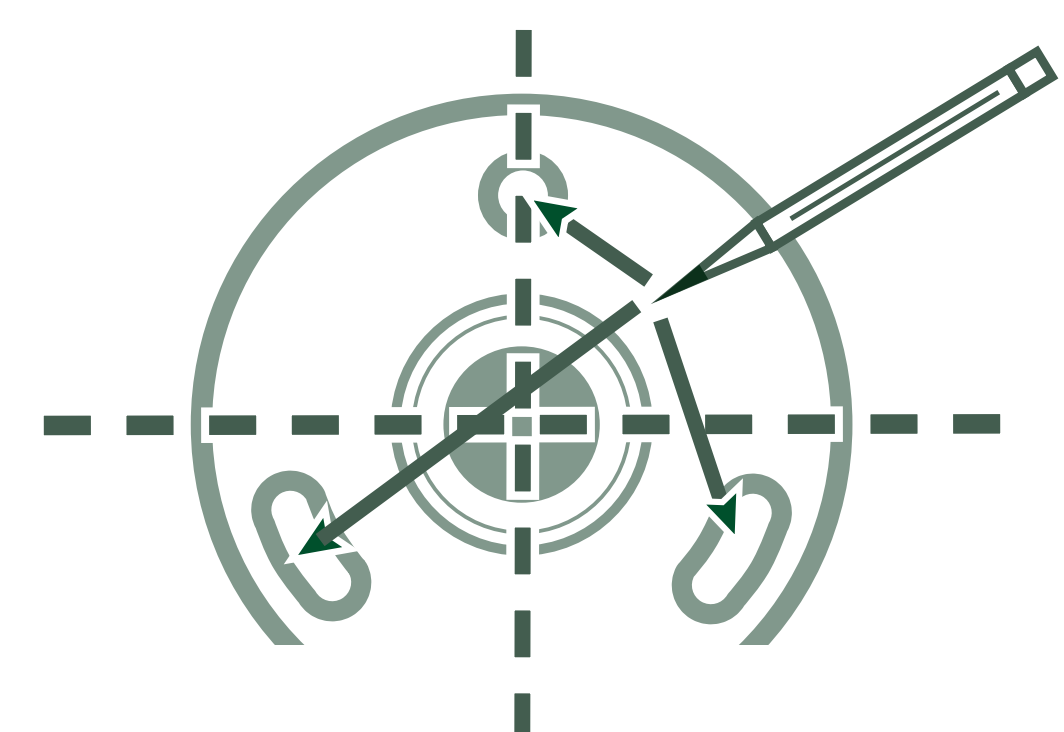

**4** If needed, install the anchors or pre-drill the holes.

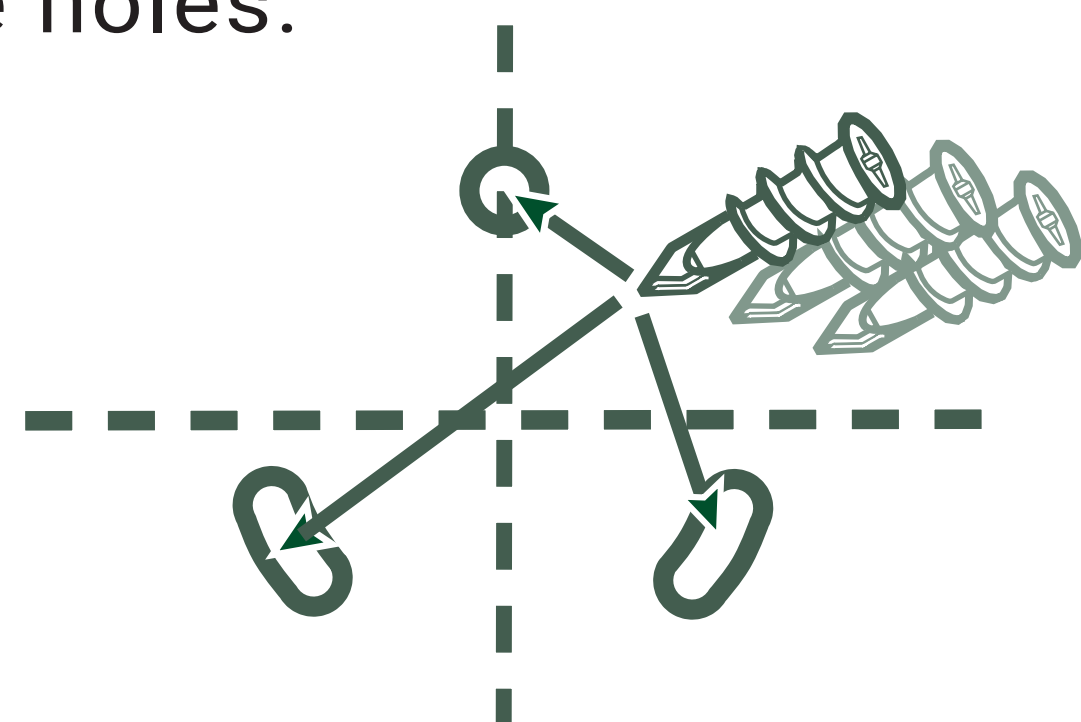

**5** Screw in the mounting plate.

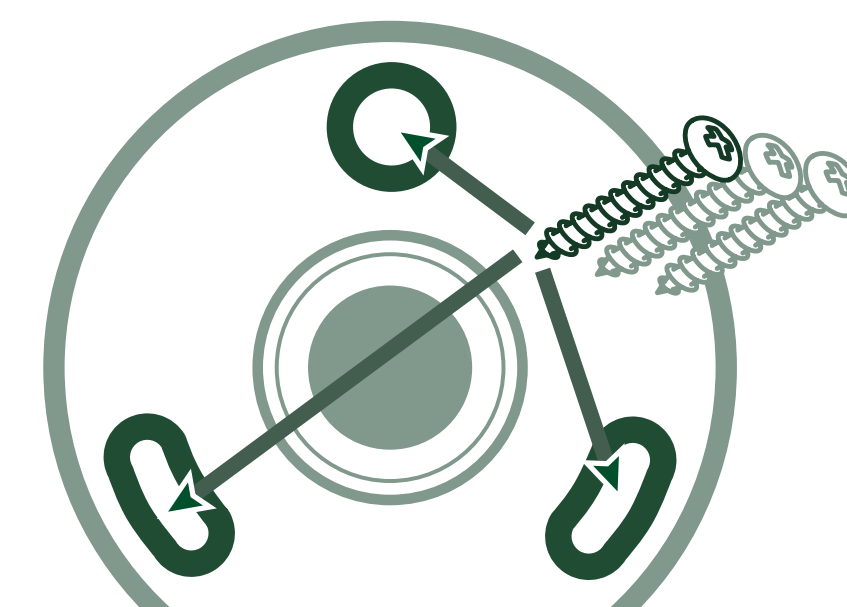

## STEP 4 ATTACHING BRACKETS TO THE ROD

 If needed, remove one of the finials before attaching brackets to the rod.

### CEILING BRACKET

**1** Detach the insert (1) from the bracket base (2) with the Allen key.

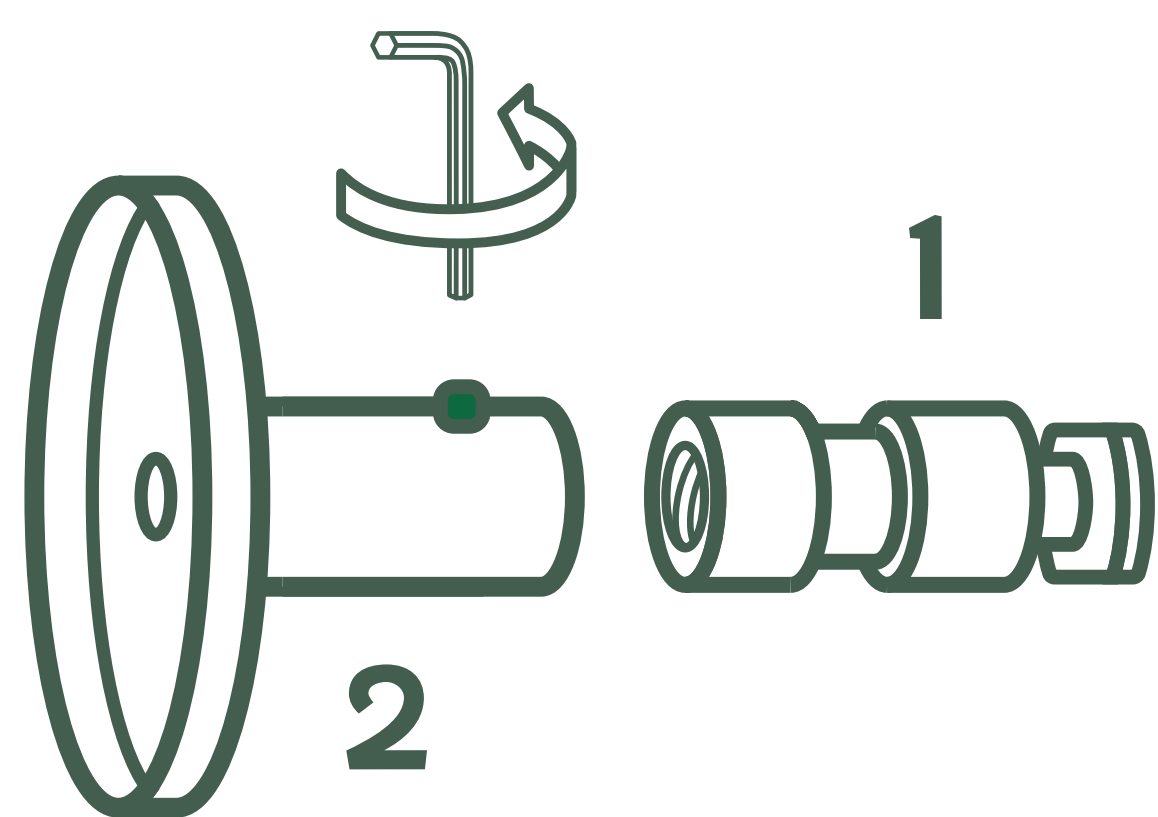

**2** Slide in the bracket's inserts (1) into the top channel (2) and secure (3) at the mounting plate positions. Use pliers if needed.

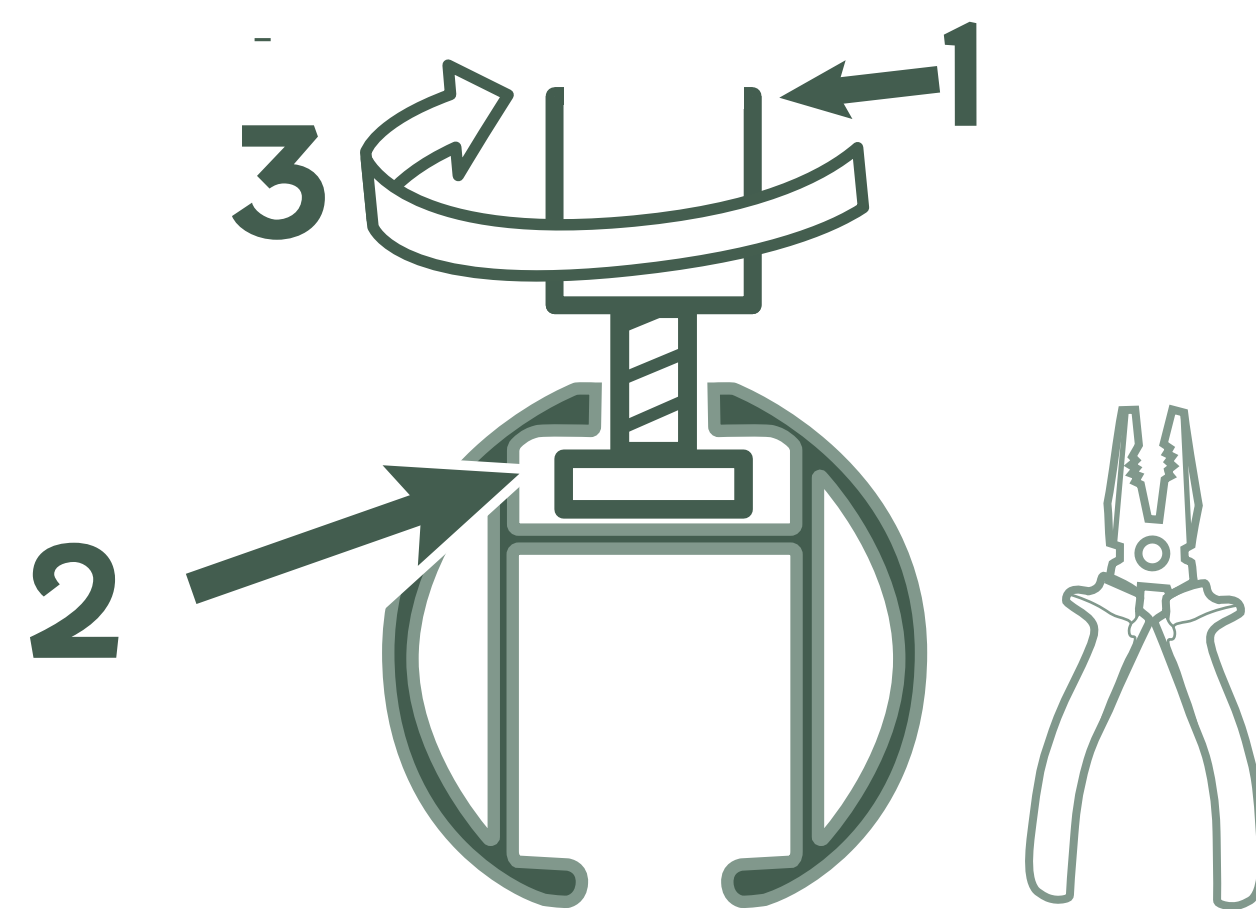

**3** Attach bracket (1) onto the mounting base (2)

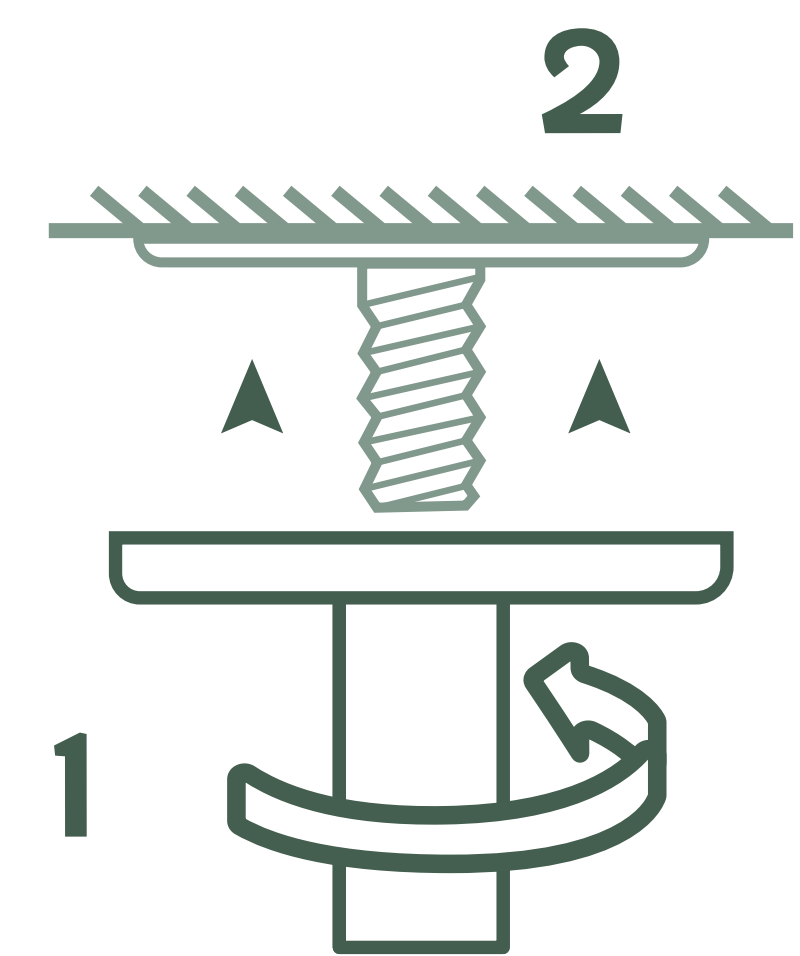

### FLASH CEILING BRACKET

**1** Slide in the flash ceiling bracket lip (1) into the rod top channel (2).

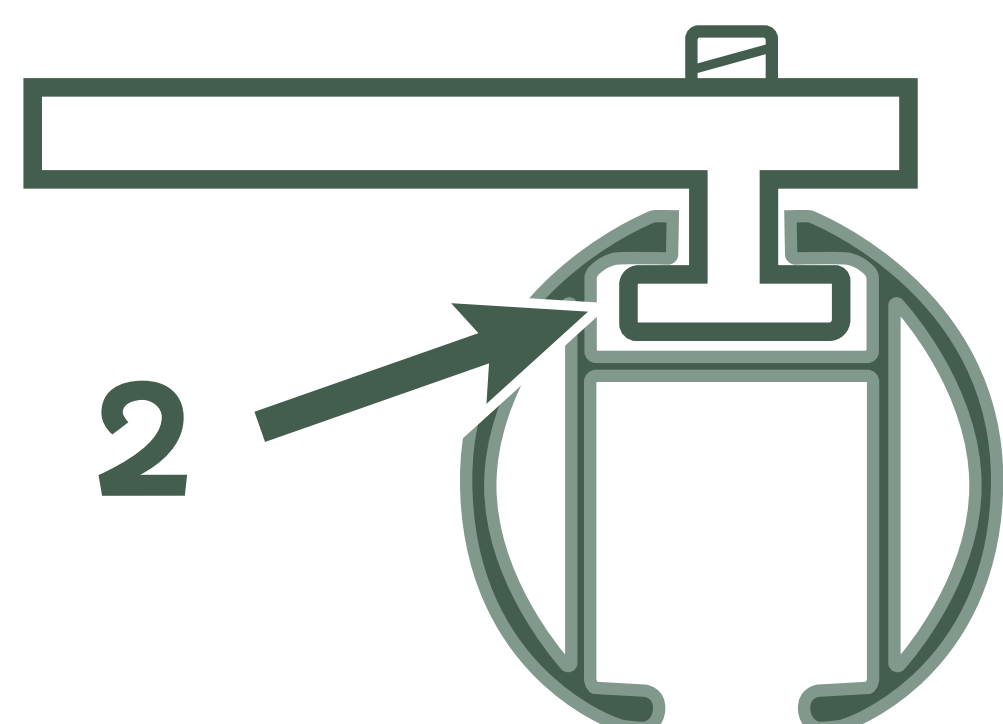

**2** Secure bracket in the marked positions with the Allen Key.

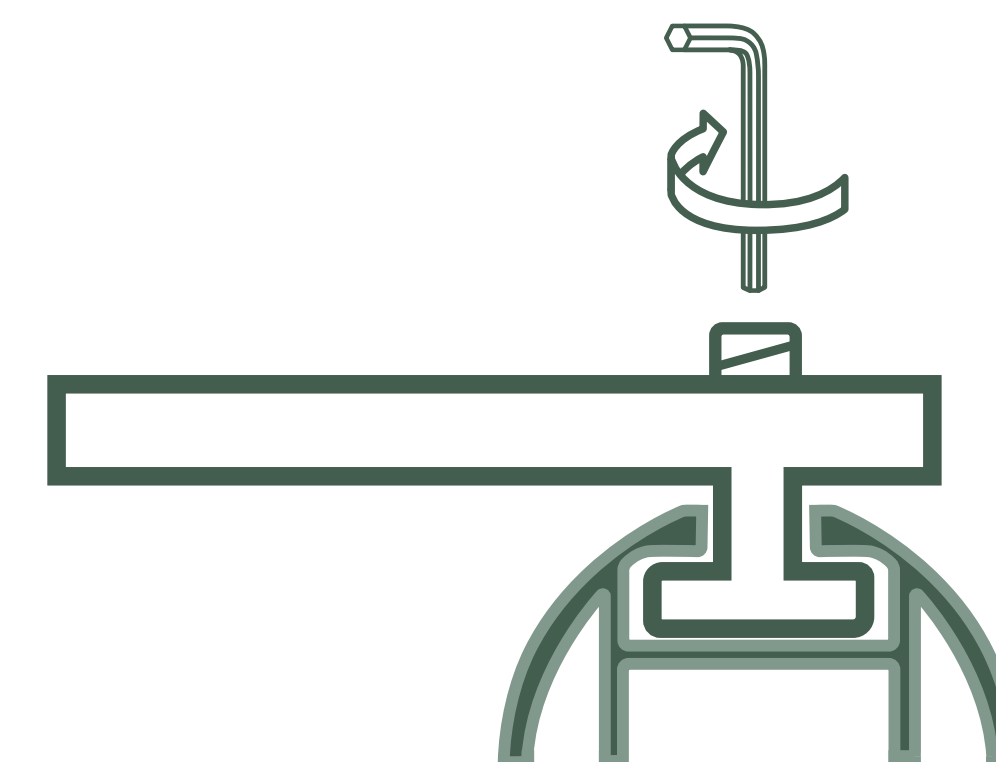

## STEP 5 MOUNTING ROD TO THE CEILING

### CEILING BRACKET

**1** With assistance lift the rod with attached brackets to the ceiling.

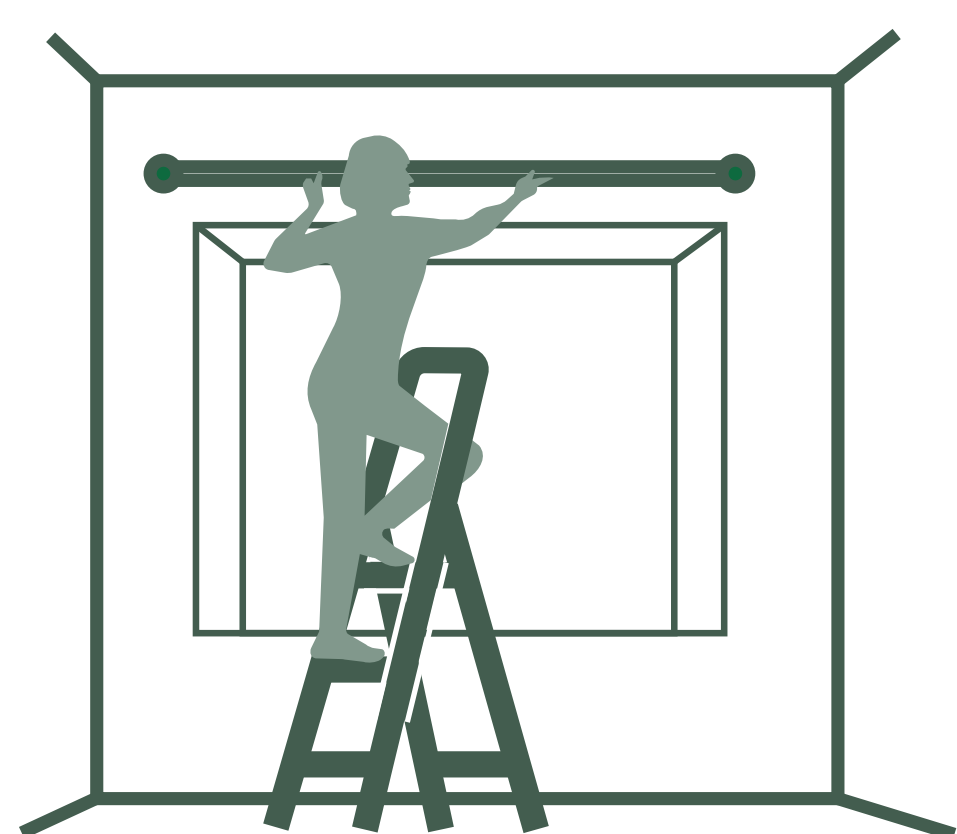

**2** Slide in the inserts to the brackets. Move and fix the insets along the rod if needed.

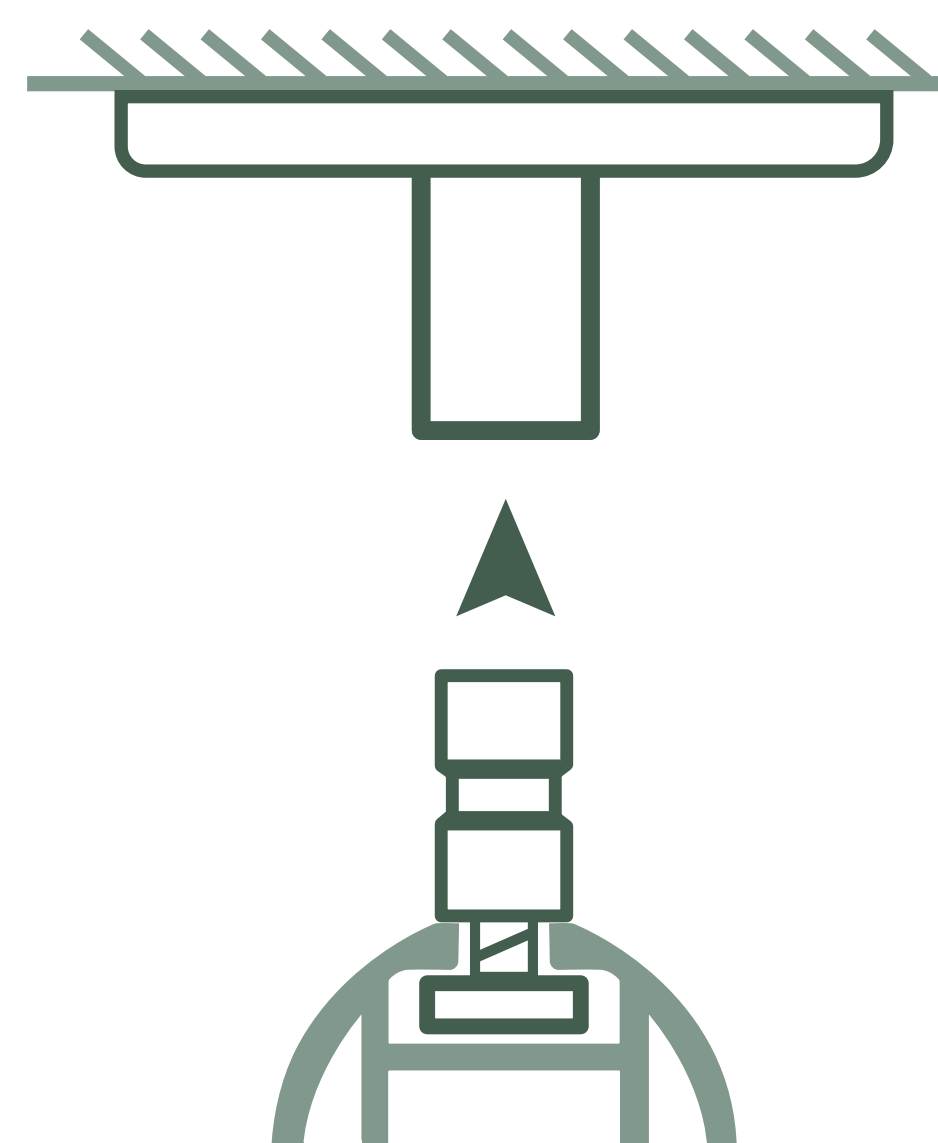

**3** Tighten the set screw with the Allen key to fully secure the bracket.

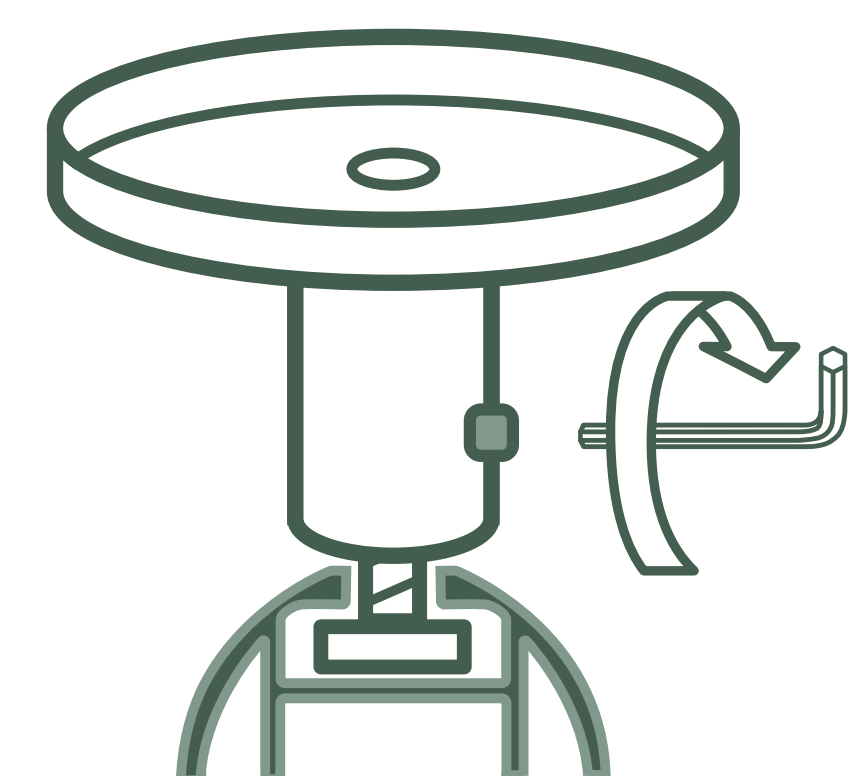

## STEP 5 MOUNTING ROD TO THE CEILING

(CONT'D)

### FLASH CEILING BRACKET

- 1** With assistance lift the rod with attached brackets to the ceiling.

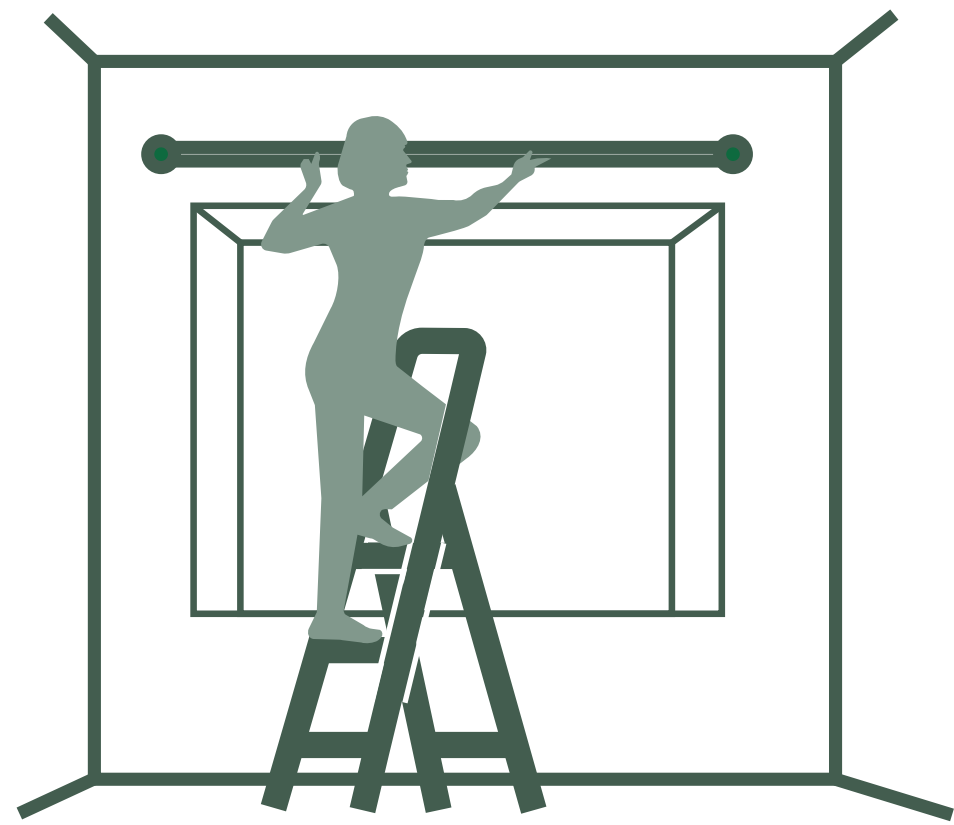

- 2** Screw in the brackets to securely attach the rod to the ceiling.

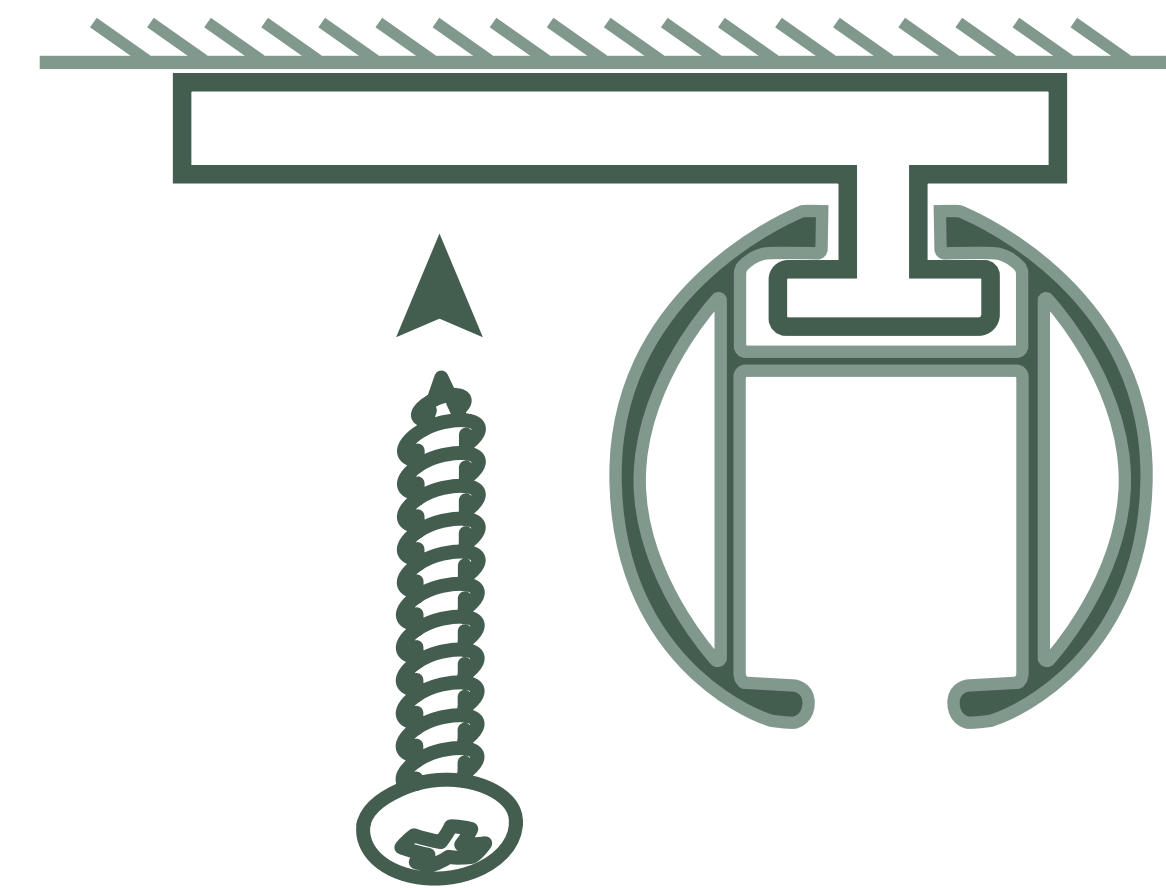

## STEP 6 FINISHING TOUCHES

- 1** Secure the finials removed earlier.

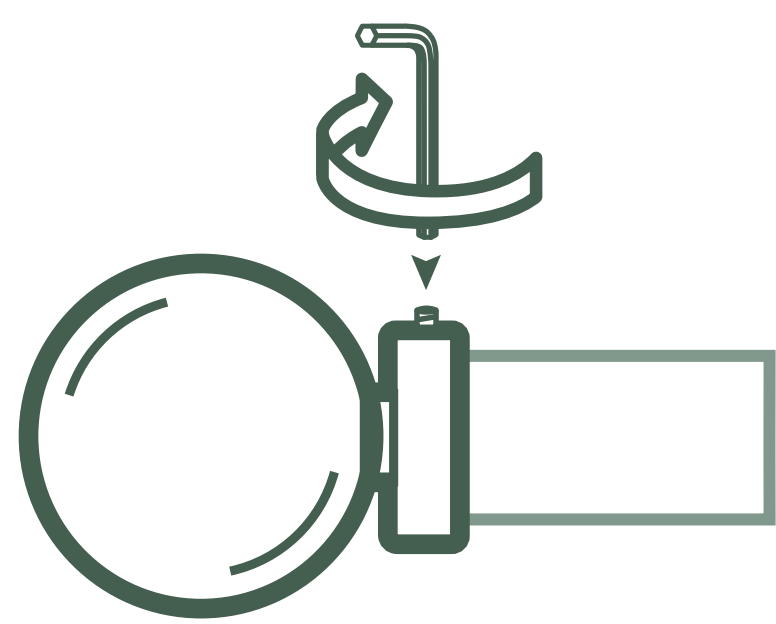

- 2** Check that the end carriers are secured (not moveable) and the rest of the carriers move freely along the track.

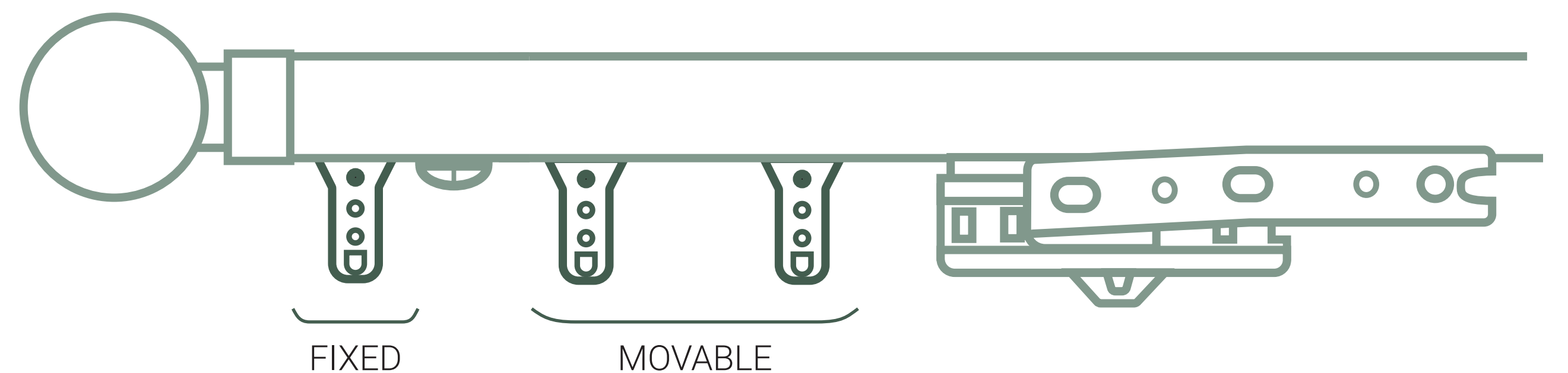

- 3** Check that the master carriers meet at the center of the track or reach the end for one-way tracks.

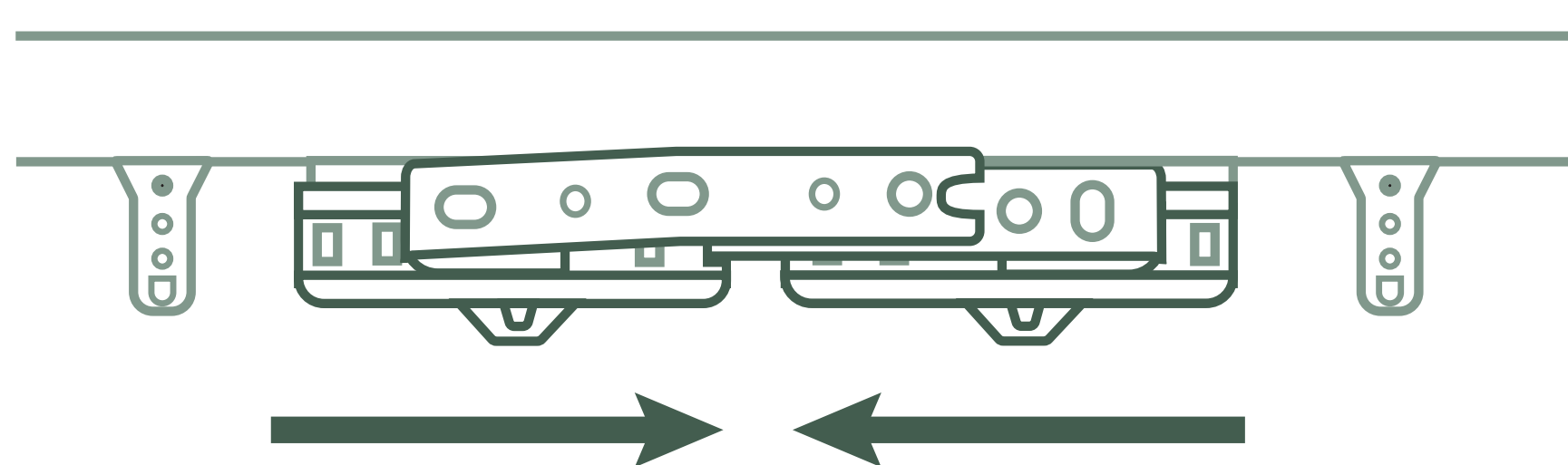

- 4** If purchased, attach wands to the master carriers.

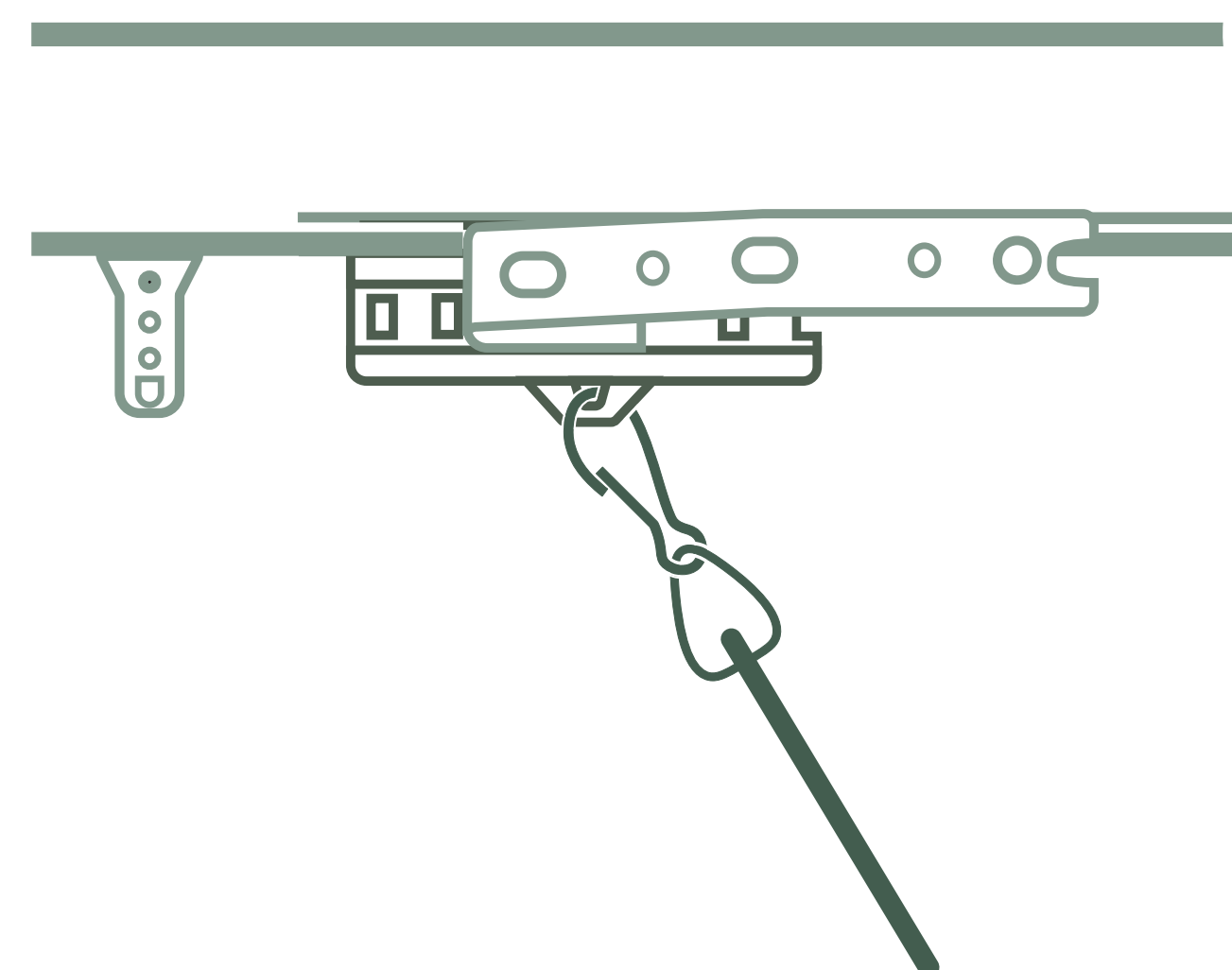

Congratulations, job well done! Still have questions? Customer Care is available at 1.800.256.5005.

**THANK YOU FOR CHOOSING REGAL DRAPES.**

WE ARE PROUD TO MAKE YOUR DRAPES WITH CAREFUL ATTENTION TO EVERY DETAIL. WE HOPE YOU ENJOY YOUR DRAPES FOR MANY YEARS TO COME.